

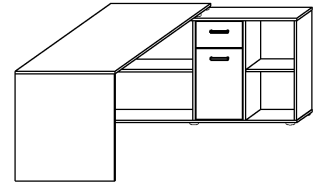

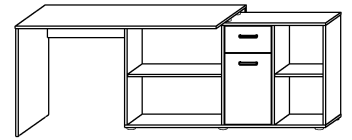







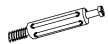

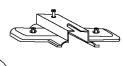
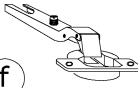
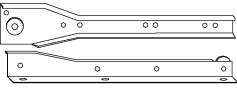
BEAT P

→ 206 ↑ 75 \ 68



→ 137 ↑ 75 \ 136

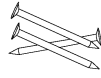
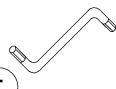

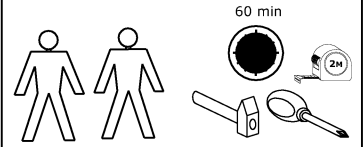
x 12 	x 16 	x 18 	x 18 	x 2 	x 2 
x 1 kpl. (300 mm) 	x 2 	x 2 	x 12 	x 1 	
x 10 	x 16 (3,5x16) 	x 6 (3,5x30) 	x 2 	x 90 	x 1 







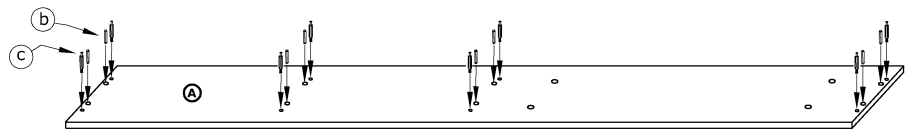

1

x 8 	x 8 
--	--

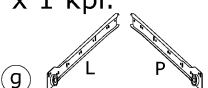

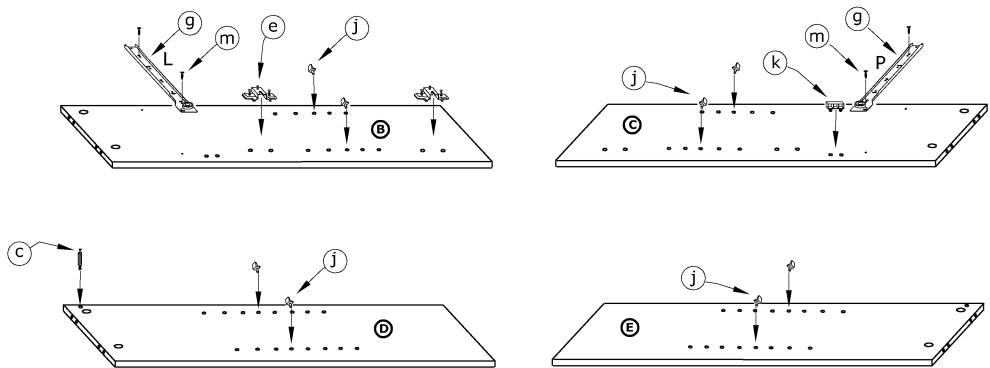

2

x 1 	x 2 
x 1 kpl. 	
x 8 	x 1 
x 4 (3,5x16) 	



3

x 1 	x 2 
x 2 	

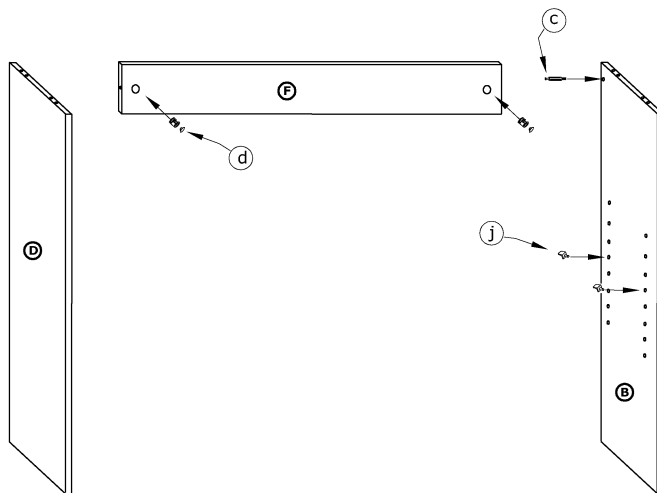

4

x 8



(a)

x 8



(d)

x 2

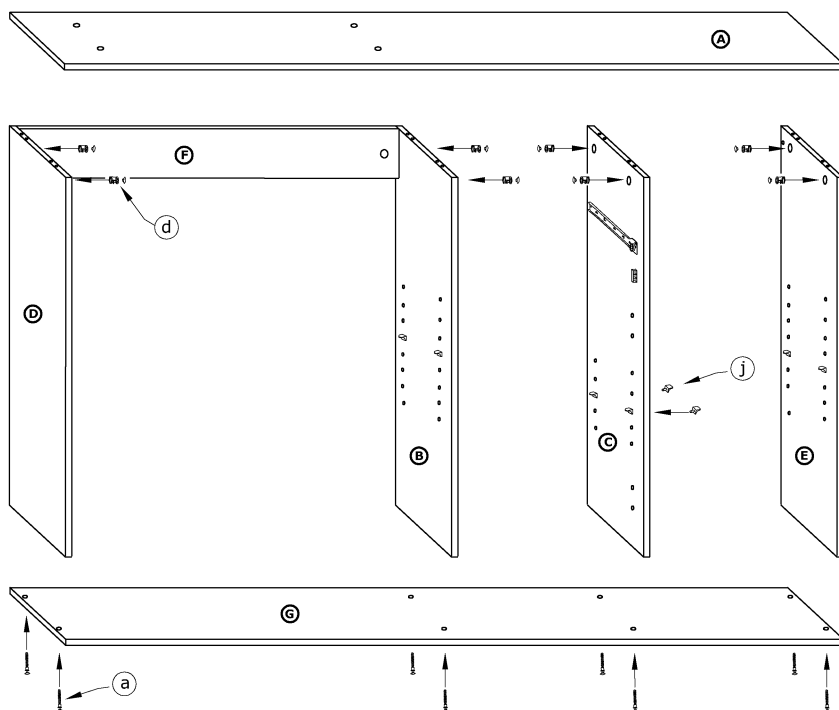

(j)

**5**

x 6



(l)

x 70

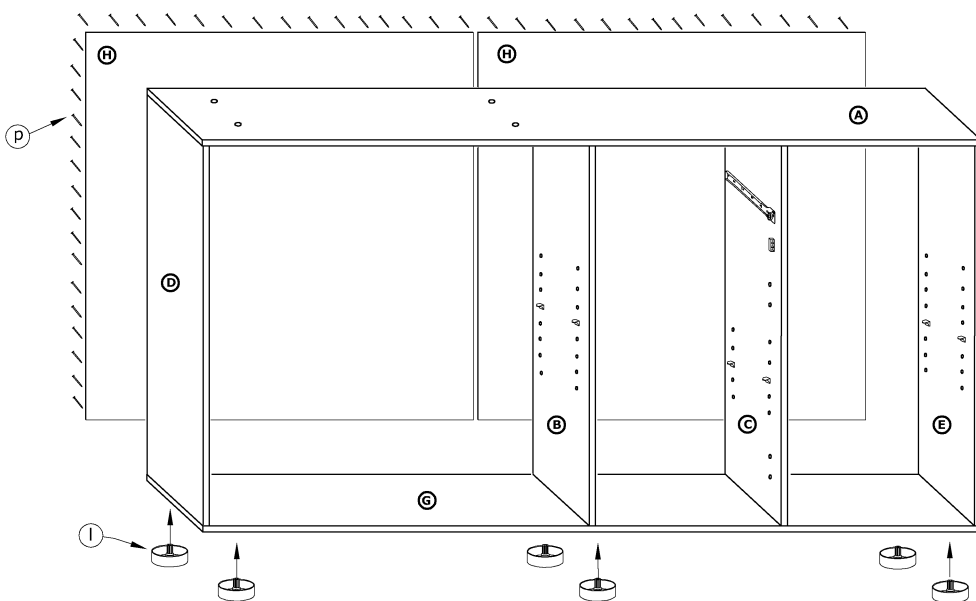

(p)

**6**

x 4



(a)

x 20

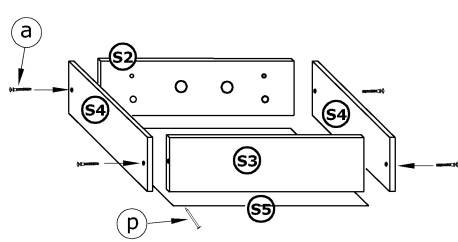

(p)

**7**

x 1 kpl.

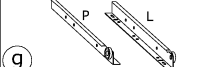

(g)

x 1



(h)

x 6



(m)

x 2



(i)





x 2

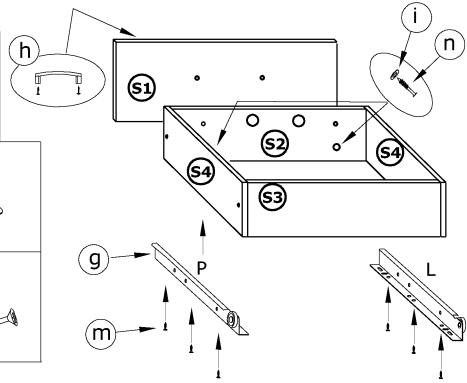

(n)

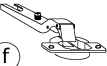

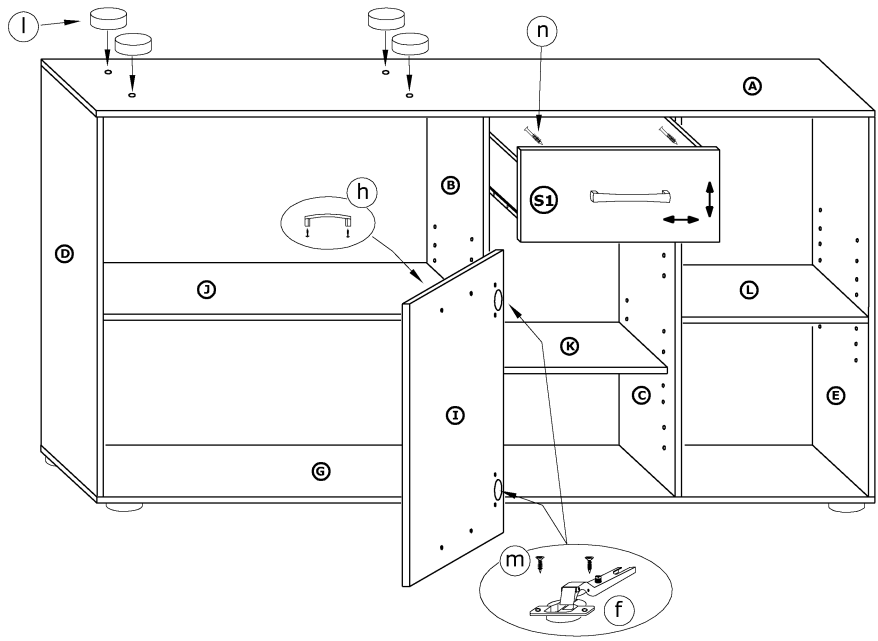

8

- x 2

- x 1

- x 4

- x 4
(3,5x16)

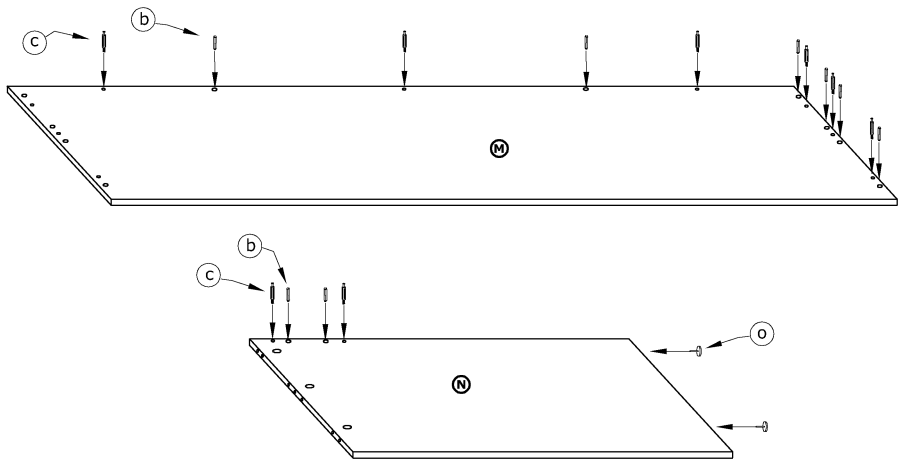
- x 2
(3,5x30)





9

- x 8

- x 8

- x 2

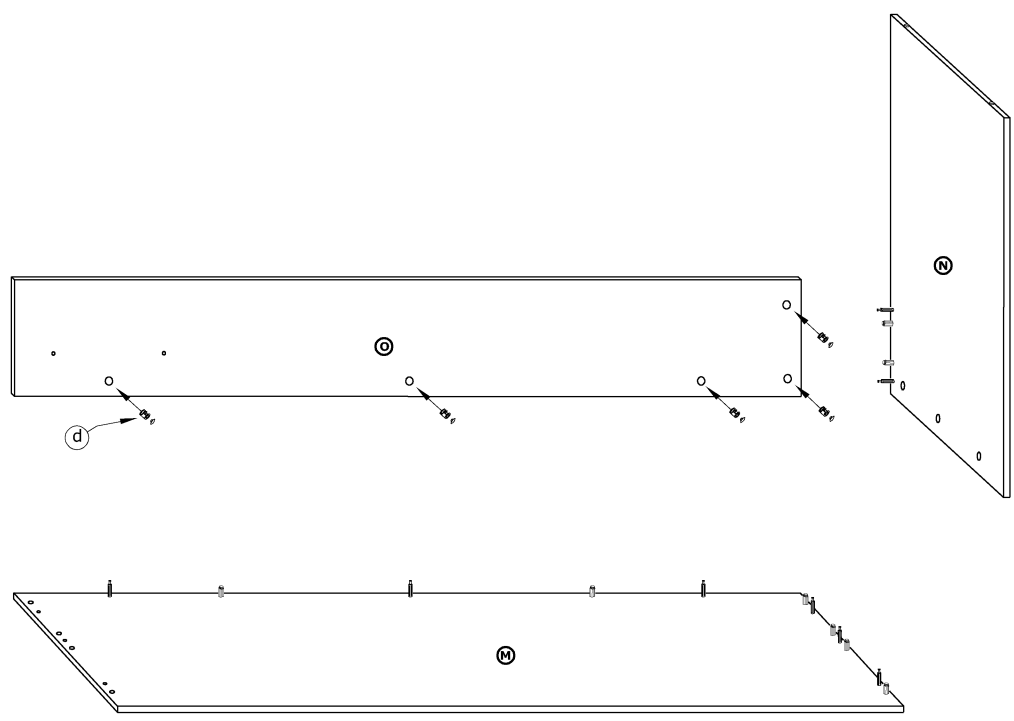

10

- x 5



11

x 2
(3,5x30)

n

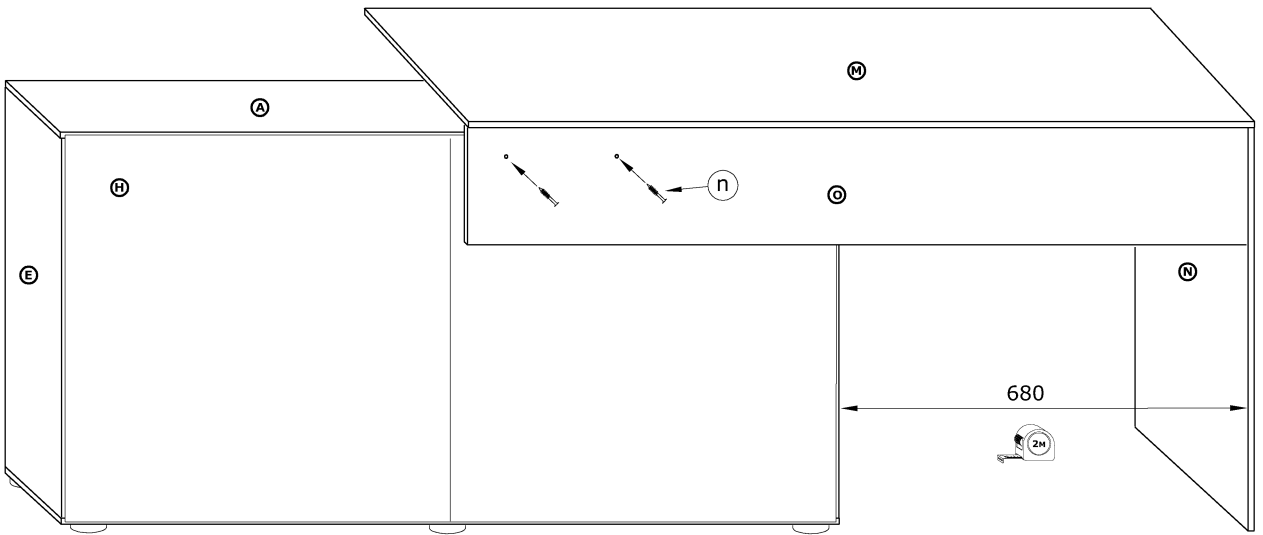

11

x 2
(3,5x30)

n

